

VB 304 UK

# 2614 PNEUMATIC VIBRATOR



Oscillating piston type has cushioned forward and reverse strokes, which together with the muffled exhaust ports make the unit barely audible within its frequency range of 38 to 45 cps.

## Applications

- Jogging cut paper
- Small feed trays
- Small compacting tables
- Flexible plates inside hoppers

## Industries

- Paper
- Printing
- Packaging
- Plastics

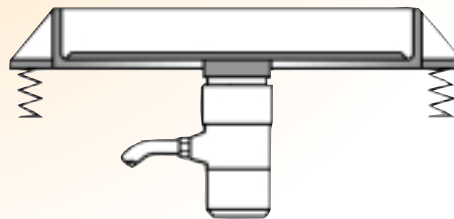

Small compacting tables

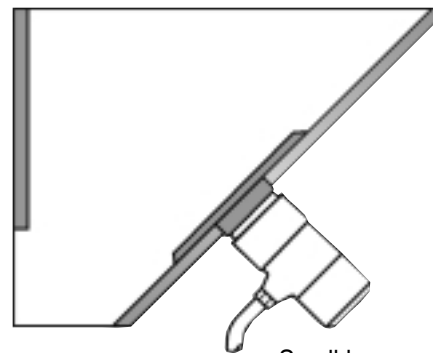

Small hoppers

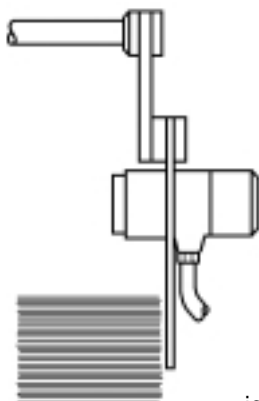

jogging cut paper

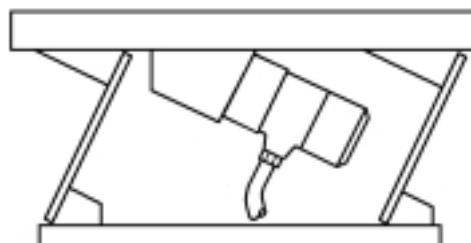

Transfer chutes

# 2614 PNEUMATIC VIBRATOR

## Installation

### Securing

Two 6mm bolts and lock washers.

### Connection

Connect air supply to inlet piece with 9mm bore flexible hose.

### Starting

Air pressure from 0.35kg/cm<sup>2</sup> (5 psi) suddenly applied will generate auto-start. When air pressure is gradually applied, a mechanical shock is required to start.



## Performance data

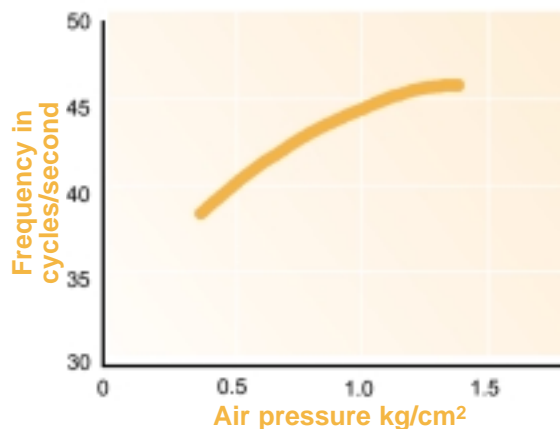
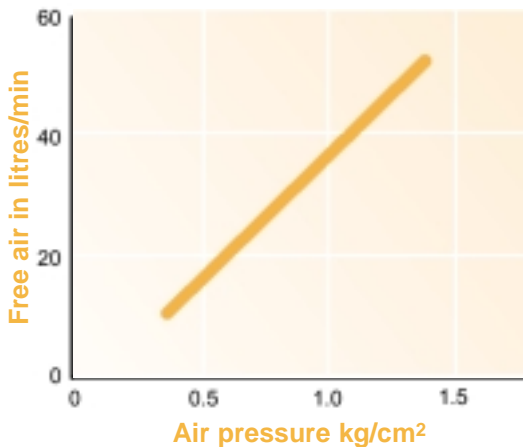

## Dimensions

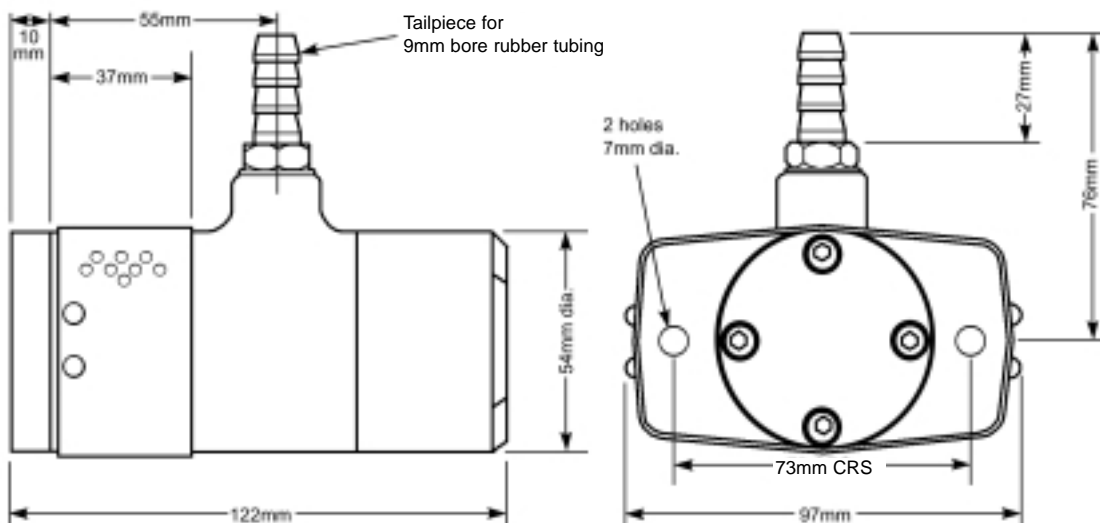

Eriez Magnetics Europe Limited  
Manufacturing Design Laboratory Headquarters  
Bedwas House Industrial Estate  
Bedwas, Caerphilly, CF83 8YG UK  
Telephone: 029 2086 8501 Fax: 029 2085 1314  
Int Tel: +44 29 2086 8501 Int Fax: +44 29 2085 1314  
E-mail: eriez@eriezeurope.co.uk  
web: www.eriez.com